

CLEAR

Art.CLE130301-CLE71PF101

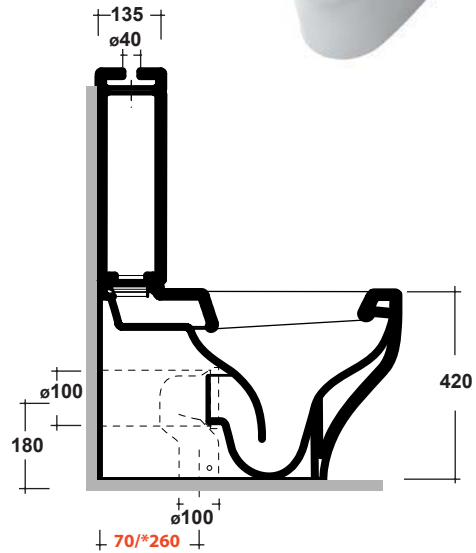
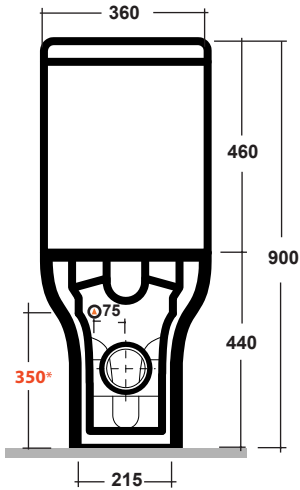
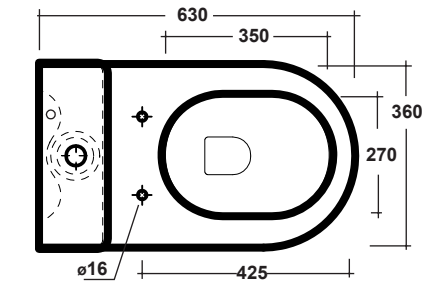

* Quota d'installazione consigliata
* Advised measure for installation

Agg. 01/2021

Monoblocco con raccordo per scarico a pavimento regolabile, fissaggi inclusi. Peso 27+13Kg
Clouse coupled bow pipe for floor drain adjustable, fixing included. Weight Kg 27+13

MAETERIALE / MATERIAL: Vitreous China

Complementi/Complement

Art.RASCTD*

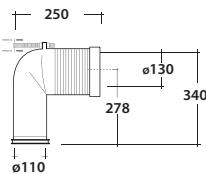

Raccordo per scarico a pavimento regolabile da 7 a 19 cm. Peso 0,3Kg
Elbow pipe for floor. Adjustable 7 a 19 cm. Weight 0,3Kg

Art.RASB*

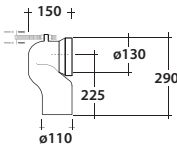

Raccordo per scarico a pavimento regolabile da 20 a 22 cm. Peso 0,3Kg
Elbow pipe for floor. Adjustable 20 a 22 cm. Weight 0,3Kg

Art.RAR1*

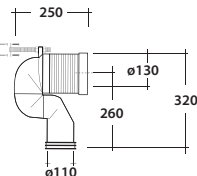

Raccordo per scarico a pavimento regolabile da 17 a 26 cm. Peso 0,3Kg
Elbow pipe for floor. Adjustable 17 a 26 cm. Weight 0,3Kg

Art.RASP**

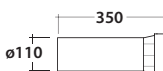

Raccordo per scarico a parete cm 35. Peso 0,25 Kg
Pipe for wall drain 35cm. Weight 0,25 Kg

CE

Manutenzione/Maintenance

Pulire con acqua e sapone o altri prodotti adatti, evitare prodotti abrasivi o aggressivi.

Please clean with water and soap or other suitable products, please avoid any aggressive or abrasive product.